

Einwegprinzip

Funktionsweise nach dem Prinzip der Einweglichtschranken. Zwei getrennte Sensorköpfe fungieren als Sender bzw. Empfänger. Die Reichweite ist abhängig vom verwendeten Verstärker.

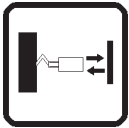

Taster

Funktionsweise nach dem Prinzip der Reflexionslichttaster. Sender und Empfänger sind als getrennte Faserbündel in einem Lichtleiter vereint. Die Tastweite ist abhängig vom verwendeten Verstärker.

Kabelmantel aus Silikon oder Metall

Typenschlüssel

Beispiel: **LLK 2 030 S R B Q - 90 - 4,0 - 2,5**

Lichtleitkabel

Funktionsprinzip

- 1 = 1-armig (Taster)
- 2 = 2-armig (Sender/Empfänger getrennt)

Kabellänge in cm

Ummantelung

- S = Silikon
- M = Metall

Lichtaustritt

- keine Angabe = axial
- R = radial

Besonderheiten

- B = biegsamer Sensorkopf

Ausführung Sensorkopf

- keine Angabe = zylindrisch
- Q = Quader

Biegung Sensorkopf

- keine Angabe = gerade
- 90 = 90° abgewinkelt (bei Quader: 90 = seitlicher Lichtaustritt)

Quader

- bei Quader: aktive Zone in mm

Zylinder

- bei Zylinder: Kopfdurchmesser in mm bzw. Gewindemaß M...

Ø Faserbündel in mm

Typenbeispiele



zylindrisch, glatt

Stufentastkopf, 3,5 mm / 5,6 mm glatte Hülse aus Edelstahl. Axialer Lichtaustritt. Verstärkeranschluss mittels Adaption M18. Einsetzbar von -40°C bis + 200°C.



zylindrisch, Gewinde

Sensorkopf mit Gewinde M6 aus Edelstahl. Axialer Lichtaustritt. Verstärkeranschluss mittels Adaption M18. Einsetzbar von -40°C bis + 200°C.



glatte Hülse, radiale Optik

Glatte Hülse, einseitig abgeflacht mit radialem Lichtaustritt. Länge 35 mm. Verstärkeranschluss mittels Adaption M18. Einsetzbar von -40°C bis + 200°C.

Einwegprinzip und Taster

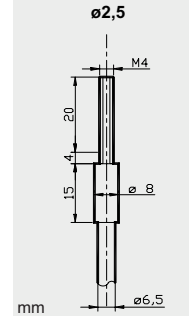
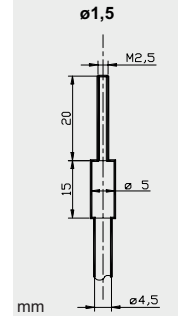
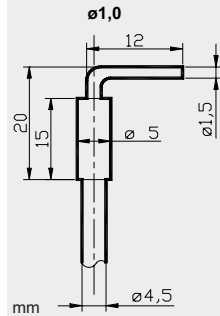
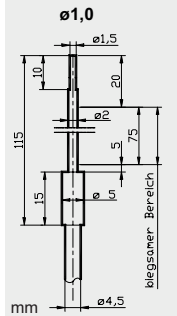
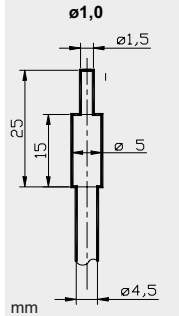
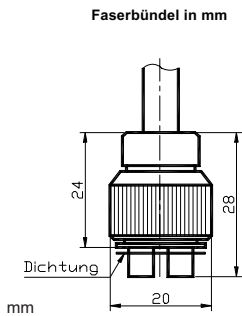

Taster

Tastweite (1-armig)	
Ummantelung Länge / mm	
Silikon	300
	600
	1000
Metall	300
	600
	1000
fett gedruckt Vorzugstypen	

10mm	10mm	10mm	25mm	40mm
Typ	Typ	Typ	Typ	Typ
LLK1030S-1,5-1,0 LLK1060S-1,5-1,0 LLK1100S-1,5-1,0 LLK1030M-1,5-1,0 LLK1060M-1,5-1,0 LLK1100M-1,5-1,0	LLK1030SB-2,0-1,0 LLK1060SB-2,0-1,0 LLK1100SB-2,0-1,0 LLK1030MB-2,0-1,0 LLK1060MB-2,0-1,0 LLK1100MB-2,0-1,0	LLK1030S-90-1,5-1,0 LLK1060S-90-1,5-1,0 LLK1100S-90-1,5-1,0 LLK1030M-90-1,5-1,0 LLK1060M-90-1,5-1,0 LLK1100M-90-1,5-1,0	LLK1030S-M2,5-1,5 LLK1060S-M2,5-1,5 LLK1100S-M2,5-1,5 LLK1030M-M2,5-1,5 LLK1060M-M2,5-1,5 LLK1100M-M2,5-1,5	LLK1030S-M4-2,5 LLK1060S-M4-2,5 LLK1100S-M4-2,5 LLK1030M-M4-2,5 LLK1060M-M4-2,5 LLK1100M-M4-2,5

Einwegprinzip

Reichweite (2-armig)	
Ummantelung Länge / mm	
Silikon	300
	600
	1000
Metall	300
	600
	1000
fett gedruckt Vorzugstypen	

120mm	120mm	120mm	150mm	600mm
Typ	Typ	Typ	Typ	Typ
LLK2030S-1,5-1,0 LLK2060S-1,5-1,0 LLK2100S-1,5-1,0 LLK2030M-1,5-1,0 LLK2060M-1,5-1,0 LLK2100M-1,5-1,0	LLK2030SB-2,0-1,0 LLK2060SB-2,0-1,0 LLK2100SB-2,0-1,0 LLK2030MB-2,0-1,0 LLK2060MB-2,0-1,0 LLK2100MB-2,0-1,0	LLK2030S-90-1,5-1,0 LLK2060S-90-1,5-1,0 LLK2100S-90-1,5-1,0 LLK2030M-90-1,5-1,0 LLK2060M-90-1,5-1,0 LLK2100M-90-1,5-1,0	LLK2030S-M2,5-1,5 LLK2060S-M2,5-1,5 LLK2100S-M2,5-1,5 LLK2030M-M2,5-1,5 LLK2060M-M2,5-1,5 LLK2100M-M2,5-1,5	LLK2030S-M4-2,5 LLK2060S-M4-2,5 LLK2100S-M4-2,5 LLK2030M-M4-2,5 LLK2060M-M4-2,5 LLK2100M-M4-2,5

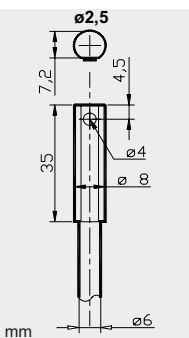
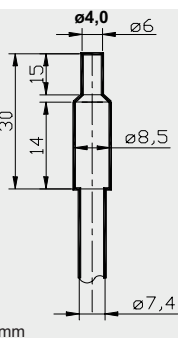
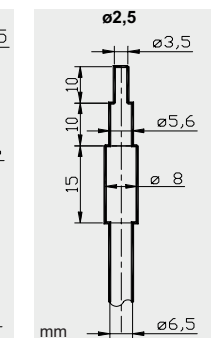
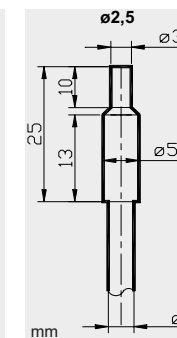
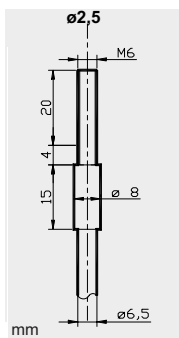
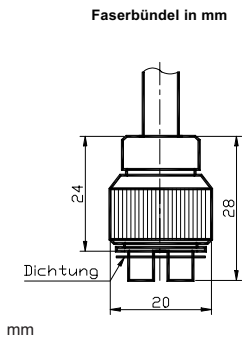

Taster

Tastweite (1-armig)	
Ummantelung Länge / mm	
Silikon	300
	600
	1000
Metall	300
	600
	1000
fett gedruckt Vorzugstypen	

40mm	40mm	40mm	80mm	50mm
Typ	Typ	Typ	Typ	Typ
LLK1030S-M6-2,5 LLK1060S-M6-2,5 LLK1100S-M6-2,5 LLK1030M-M6-2,5 LLK1060M-M6-2,5 LLK1100M-M6-2,5	LLK1030S-5,6-2,5 LLK1060S-5,6-2,5 LLK1100S-5,6-2,5 LLK1030M-5,6-2,5 LLK1060M-5,6-2,5 LLK1100M-5,6-2,5	LLK1030S-8,0-2,5 LLK1060S-8,0-2,5 LLK1100S-8,0-2,5 LLK1030M-8,0-2,5 LLK1060M-8,0-2,5 LLK1100M-8,0-2,5	LLK1030S-8,5-4,0 LLK1060S-8,5-4,0 LLK1100S-8,5-4,0 LLK1030M-8,5-4,0 LLK1060M-8,5-4,0 LLK1100M-8,5-4,0	LLK1030SR-8,0-2,5 LLK1060SR-8,0-2,5 LLK1100SR-8,0-2,5 LLK1030MR-8,0-2,5 LLK1060MR-8,0-2,5 LLK1100MR-8,0-2,5

Einwegprinzip

Reichweite (2-armig)	
Ummantelung Länge / mm	
Silikon	300
	600
	1000
Metall	300
	600
	1000
fett gedruckt Vorzugstypen	

800mm	600mm	600mm	800mm	500mm
Typ	Typ	Typ	Typ	Typ
LLK2030S-M6-2,5 LLK2060S-M6-2,5 LLK2100S-M6-2,5 LLK2030M-M6-2,5 LLK2060M-M6-2,5 LLK2100M-M6-2,5	LLK2030S-5,6-2,5 LLK2060S-5,6-2,5 LLK2100S-5,6-2,5 LLK2030M-5,6-2,5 LLK2060M-5,6-2,5 LLK2100M-5,6-2,5	LLK2030S-8,0-2,5 LLK2060S-8,0-2,5 LLK2100S-8,0-2,5 LLK2030M-8,0-2,5 LLK2060M-8,0-2,5 LLK2100M-8,0-2,5	LLK2030S-8,5-4,0 LLK2060S-8,5-4,0 LLK2100S-8,5-4,0 LLK2030M-8,5-4,0 LLK2060M-8,5-4,0 LLK2100M-8,5-4,0	LLK2030SR-8,0-2,5 LLK2060SR-8,0-2,5 LLK2100SR-8,0-2,5 LLK2030MR-8,0-2,5 LLK2060MR-8,0-2,5 LLK2100MR-8,0-2,5

* Sonderausführungen können auf Anfrage konfektioniert werden
* Passende Verstärkerbaureihe: OLK(T) 40...

Einwegprinzip und Taster



Taster

Tastweite (1-armig)	
Ummantelung Länge / mm	
Silikon	300 600 1000
Metall	300 600 1000
fett gedruckt Vorzugstypen	

40mm	80mm	80mm
Typ	Typ	Typ
LLK1030S-90-4,0-2,5 LLK1060S-90-4,0-2,5 LLK1100S-90-4,0-2,5 LLK1030M-90-4,0-2,5 LLK1060M-90-4,0-2,5 LLK1100M-90-4,0-2,5	LLK1030SQ-10-0,6 LLK1060SQ-10-0,6 LLK1100SQ-10-0,6 LLK1030MQ-10-0,6 LLK1060MQ-10-0,6 LLK1100MQ-10-0,6	LLK1030SQ-90-10-0,6 LLK1060SQ-90-10-0,6 LLK1100SQ-90-10-0,6 LLK1030MQ-90-10-0,6 LLK1060MQ-90-10-0,6 LLK1100MQ-90-10-0,6

Einwegprinzip

Reichweite (2-armig)	
Ummantelung Länge / mm	
Silikon	300 600 1000
Metall	300 600 1000
fett gedruckt Vorzugstypen	

1000mm	800mm	800mm
Typ	Typ	Typ
LLK2030S-90-4,0-2,5 LLK2060S-90-4,0-2,5 LLK2100S-90-4,0-2,5 LLK2030M-90-4,0-2,5 LLK2060M-90-4,0-2,5 LLK2100M-90-4,0-2,5	LLK2030SQ-10-0,3 LLK2060SQ-10-0,3 LLK2100SQ-10-0,3 LLK2030MQ-10-0,3 LLK2060MQ-10-0,3 LLK2100MQ-10-0,3	LLK2030SQ-90-10-0,3 LLK2060SQ-90-10-0,3 LLK2100SQ-90-10-0,3 LLK2030MQ-90-10-0,3 LLK2060MQ-90-10-0,3 LLK2100MQ-90-10-0,3

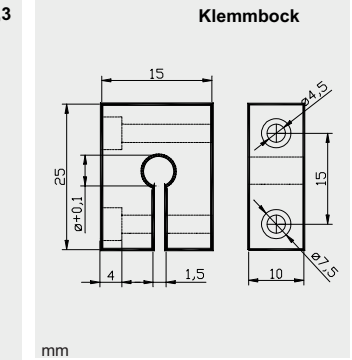
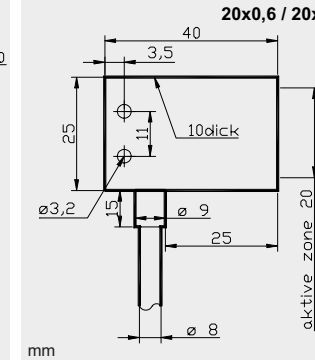
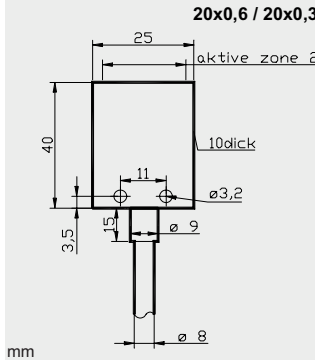
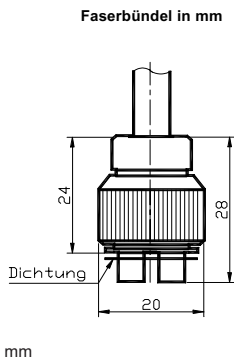

Taster

Tastweite (1-armig)	
Ummantelung Länge / mm	
Silikon	300 600 1000
Metall	300 600 1000
fett gedruckt Vorzugstypen	

100mm	100mm	ø in mm
Typ	Typ	Typ
LLK1030SQ-20-0,6 LLK1060SQ-20-0,6 LLK1100SQ-20-0,6 LLK1030MQ-20-0,6 LLK1060MQ-20-0,6 LLK1100MQ-20-0,6	LLK1030SQ-90-20-0,6 LLK1060SQ-90-20-0,6 LLK1100SQ-90-20-0,6 LLK1030MQ-90-20-0,6 LLK1060MQ-90-20-0,6 LLK1100MQ-90-20-0,6	3,5mm KLB35 5,0mm KLB50 5,6mm KLB56 6,5mm KLB65 8,0mm KLB80 8,5mm KLB85

Einwegprinzip

Reichweite (2-armig)	
Ummantelung Länge / mm	
Silikon	300 600 1000
Metall	300 600 1000
fett gedruckt Vorzugstypen	

1000mm	1000mm
Typ	Typ
LLK2030SQ-20-0,3 LLK2060SQ-20-0,3 LLK2100SQ-20-0,3 LLK2030MQ-20-0,3 LLK2060MQ-20-0,3 LLK2100MQ-20-0,3	LLK2030SQ-90-20-0,3 LLK2060SQ-90-20-0,3 LLK2100SQ-90-20-0,3 LLK2030MQ-90-20-0,3 LLK2060MQ-90-20-0,3 LLK2100MQ-90-20-0,3